



**MIRACLE INTERNATIONAL**  
**CONTRACTING & TRADING CO. LTD-UK**  
*'LETS SHARE OUR EXPERIENCE ON STRUCTURE PROTECTION'*

SUPPLY & APPLY DOMESTIC, COMMERCIAL & INDUSTRIAL ROOFING SERVICES, INSULATION, SOUND PROOFING, FLOORING, ADVANCE CONCRETE REPAIR, RESTORATION & REHABILITATION WORKS, TRADING OF PVC, EPDM, POLYUREA, ICE MELTING COMPOUNDS (CaCl<sub>2</sub>), CAUSTIC SODA (NaOH) & ELECTRICAL SUPPLIES.





# ABOUT OUR COMPANY

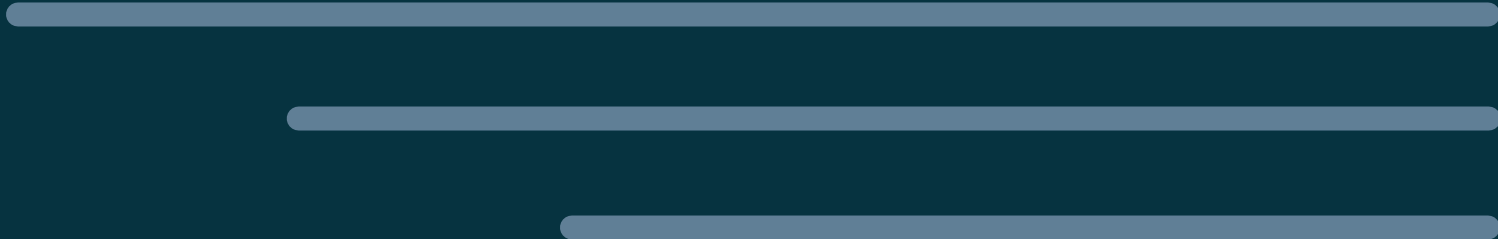

Miracle International Contracting & Trading Company, emerged from the idea of establishing an institution according to a specific vision that aspires to the broad horizon with great goals and high ambitions that are not limited by restrictions. Sabir Imam, the founder of Miracle International Contracting & Trading company, with 20+ years of experience has to reach these goals through a continuous steps and stages to achieve his vision .







# VISION & MISSION

## Vision

Our vision is to continuously innovate and create energy efficient, environmental and budget-friendly solutions and to be the best in our activities as a service provider in waterproofing, insulation, etc.

- ★ Our outlook and goals are to provide remarkable service with quality and safety as per the Client's satisfaction.
- ★ 'A great place for people to work, knowing that we provide each service with the best of our capabilities, safeguarding your assets from unnecessary damage'

## Mission

Our Mission is to provide the solutions for the people who need our knowledge and expertise, and preventing business, private people in damaging their products, valuable goods and necessities due to a poor and damaged roof, floor, concrete etc.

- ★ While doing this, we intend to bring for our customers value, good working environment for our employees and ultimately attractive returns for our stakeholders and later to achieve our target to help the society and the needy.
- ★ By maintaining good standards, providing the highest quality products and services and doing continuous research and innovative solutions help us to stay the number one insulation company in this industry.



# OUR ACTIVITIES

DOMESTIC, COMMERCIAL &  
INDUSTRIAL - CONTRACTING



## ROOFING SERVICES

We at Miracle Co. develop and deliver best in class roofing services in UK with our highly skilled and trained technicians. Our team includes the experts of Waterproofing for Flat & Pitched Roofing System. Our professional approach towards the high quality makes us the best choice for roofing services includes - Conventional Roof, Inverted Roof, Green Roof, Blue Roof, Brown Roof, Biodiverse Roof, Sedum Roof, Podium Roof and Traditional Roof.



## INSULATION

Our wide range of services offers you all types of insulation services including but not limited to Hot Insulation, Thermal Insulation, Roof Thermal Insulation, Cold Insulation, Roof Insulation, Ducting Insulation & Acoustic Insulation Services.



## SOUNDPROOFING

We execute soundproofing projects, whether that be soundproofing a home theatre, a recreation room, a music room, a quiet bedroom, a private office, mechanical noise problem or reducing noise. We specialise in soundproofing and implement effective soundproofing construction projects.



# OUR ACTIVITIES

DOMESTIC, COMMERCIAL &  
INDUSTRIAL - CONTRACTING



## FLOORING

With our epoxy coating systems, you can feel confident that your home/workshop/factory floor will last for years to come. Our high-quality materials and durable processes create a clean environment with minimal downtime.



## ADVANCE CONCRETE REPAIR

We provide All kind of concrete repairs & structural strengthening works, concrete levelling, beams, column & foundation repair services. Our team is committed to quality workmanship and customer satisfaction with every project.



## RESTORATION & REHABILITATION

We provide solutions and services for restoration & rehabilitation of old and heritage properties. Our team has the experience and capability to help you restore your property from any size damage or deterioration.

# OUR ACTIVITIES

## TRADING & SUPPLY



### ICE MELTING COMPOUND ( $\text{CaCl}_2$ )

Calcium chloride ice melt is becoming increasingly popular in the de-icing field as well as its many other applications. The reasons for its de-icing popularity include its high performance even in lower temperatures, its effectiveness even in small doses, and its eco-friendliness. Once calcium chloride gets in contact with ice and snow, it forms brine that quickly melts whatever it comes in contact with.



### CAUSTIC SODA ( $\text{NaOH}$ )

Caustic Soda (Sodium Hydroxide) is a highly corrosive, odorless, non-flammable white solid. It is usually produced as shiny pellets or flakes, which are highly water-soluble, making a slippery solution. The 50% solution is slightly viscous. Caustic Soda is a general purpose industrial chemical used extensively by process industries.



# OUR ACTIVITIES

TRADING & SUPPLY



## ELECTRO MECHANICAL EQUIPMENTS & PARTS

Associated with renowned manufacturers across North America, Europe and Asia for supply of Electro Mechanical equipments and parts.

# LETTER FROM THE FOUNDER & DIRECTOR

---

*Gain knowledge from the cradle to the grave, quality is the paramount of success, experience makes things perfect, honesty aligns beauty to life and positive thinking builds confidence and confidence builds nations.*

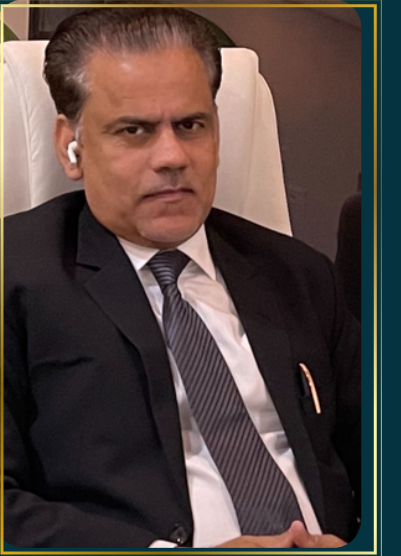

*When it comes to success, we club all of the above and provide our clients professional assistance to protect their dream structures with quality weather proofing and environment friendly solutions.*

*We are committed to resolve any Domestic, Commercial and Industrial – Structural maintenance pertaining to Waterproofing, Insulation, Flooring, Soundproofing, Concrete Repairing and Rehabilitation by providing best Technical, Commercial and Professional advice.*

Sabir Imam.

Director - MICTC LTD. UK.





# TECHNICAL DRAWINGS

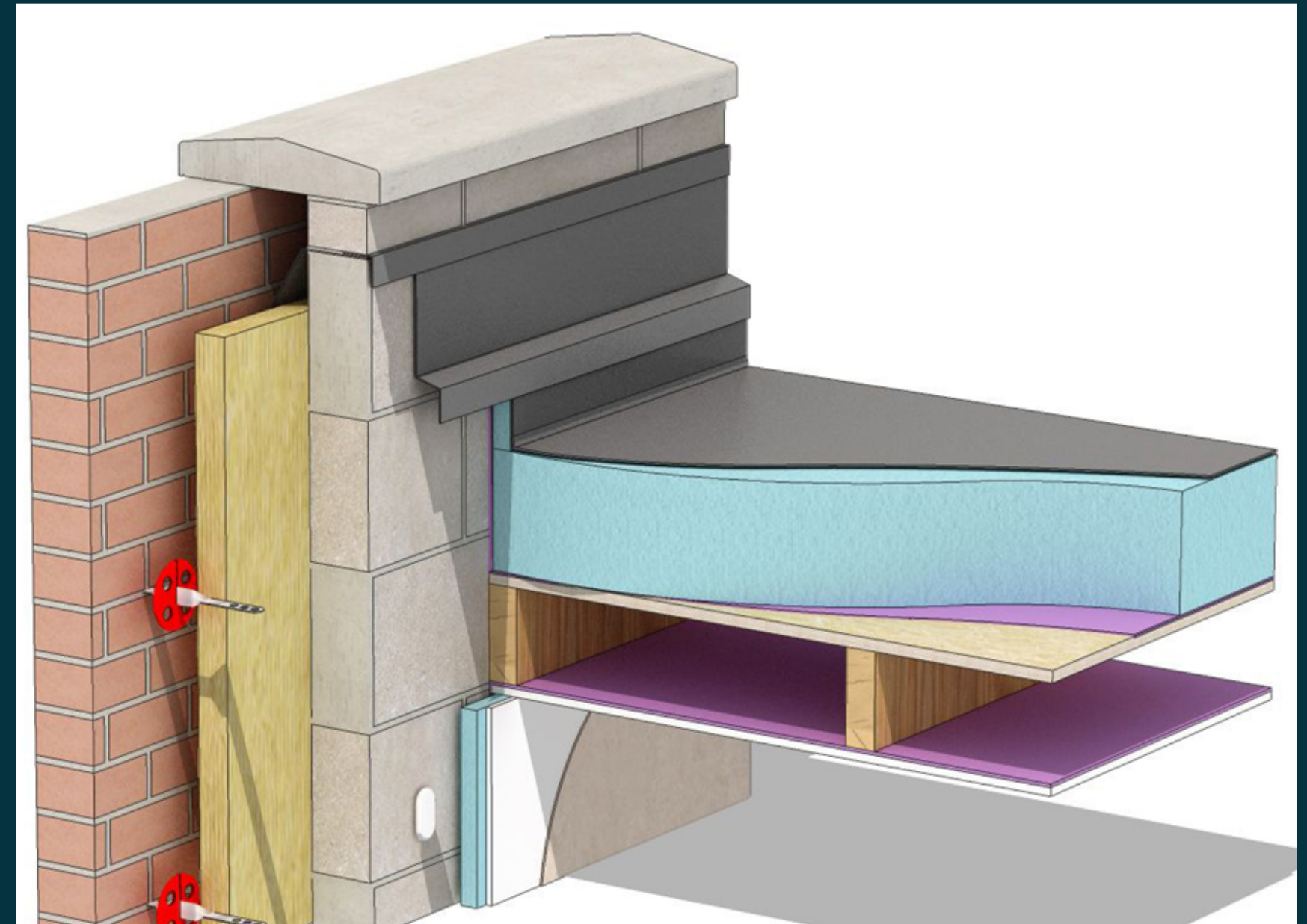
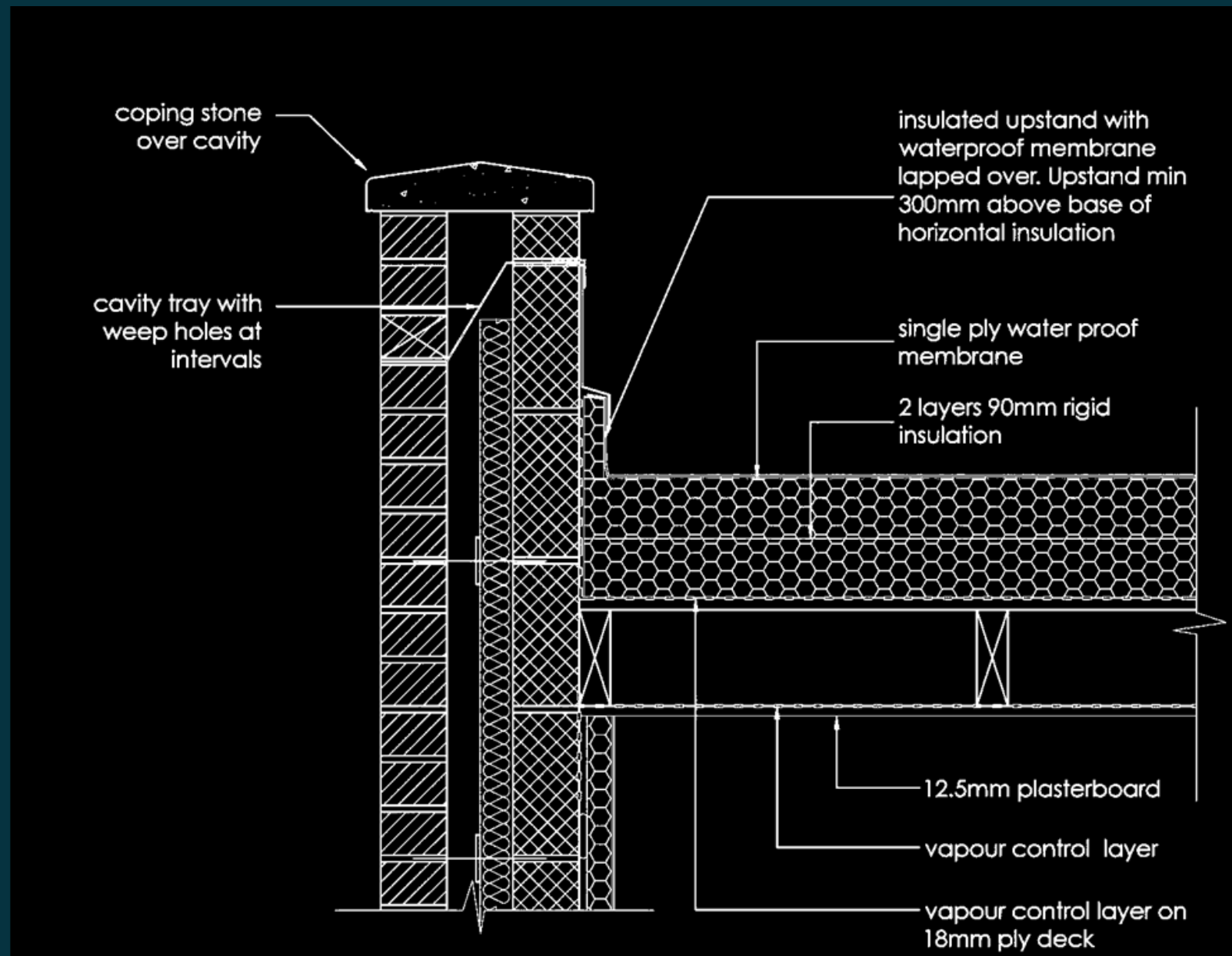

## FLAT ROOFING SYSTEM



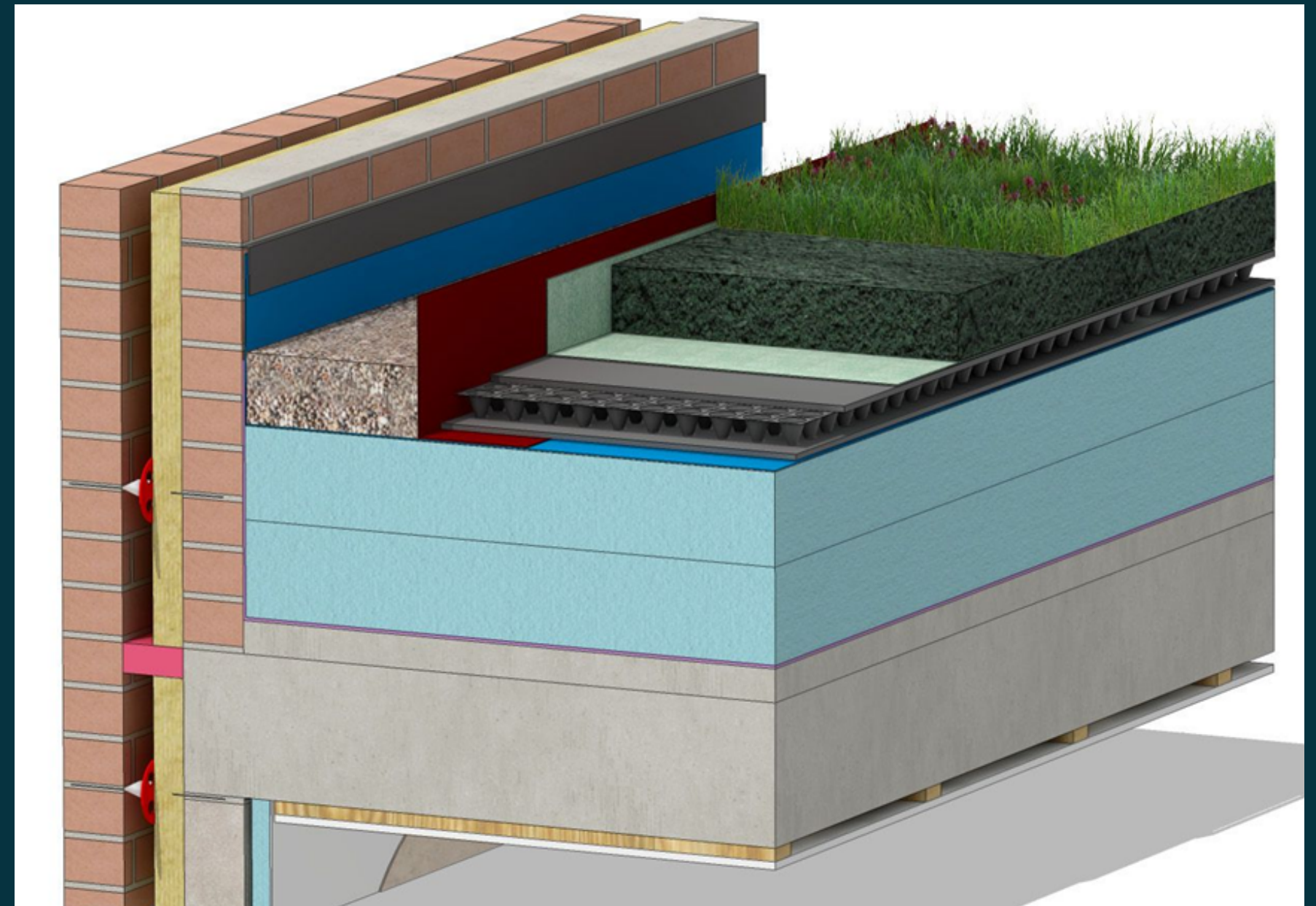
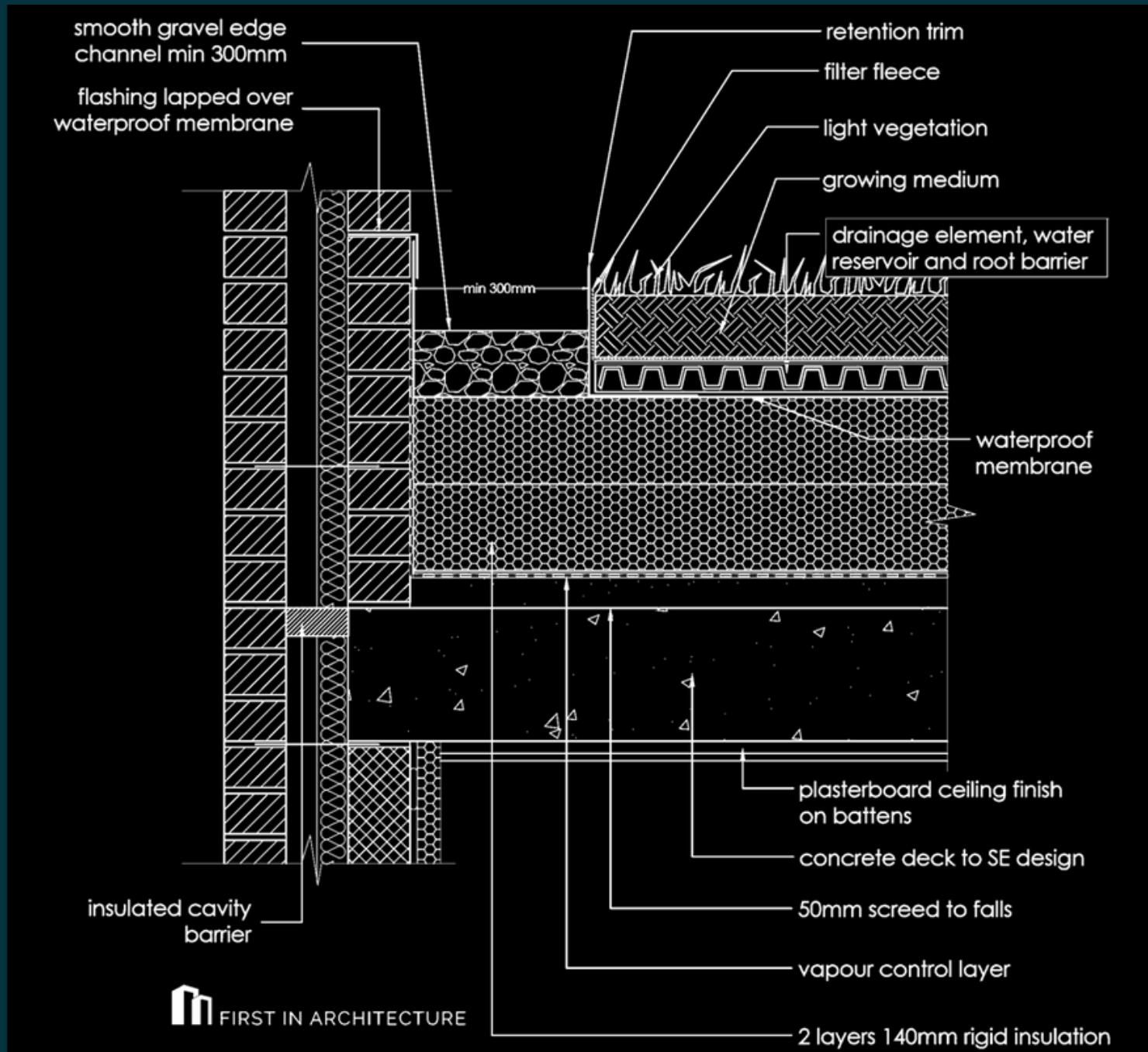

# GREEN ROOFING SYSTEM



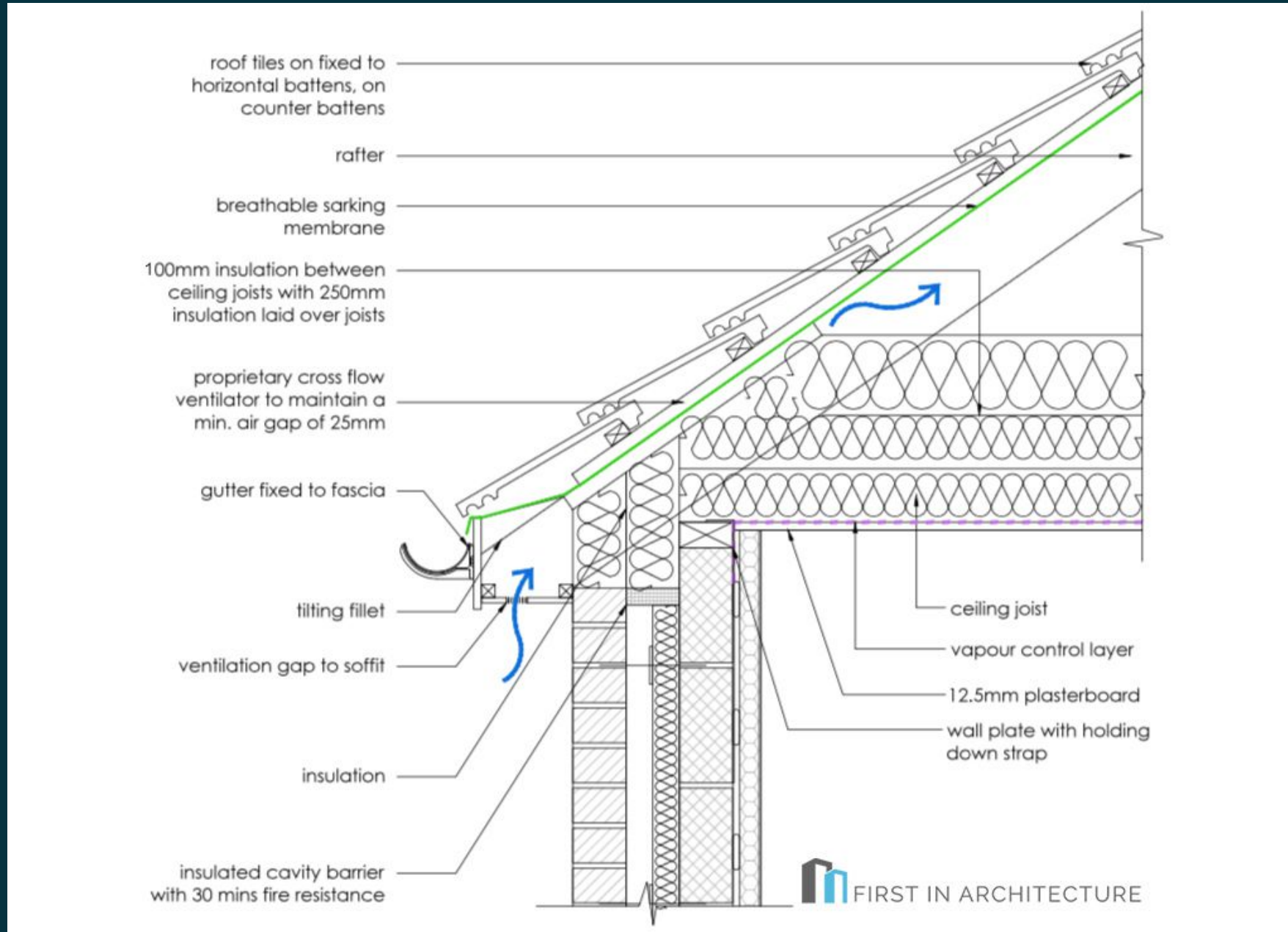

# PITCHED ROOFING SYSTEM



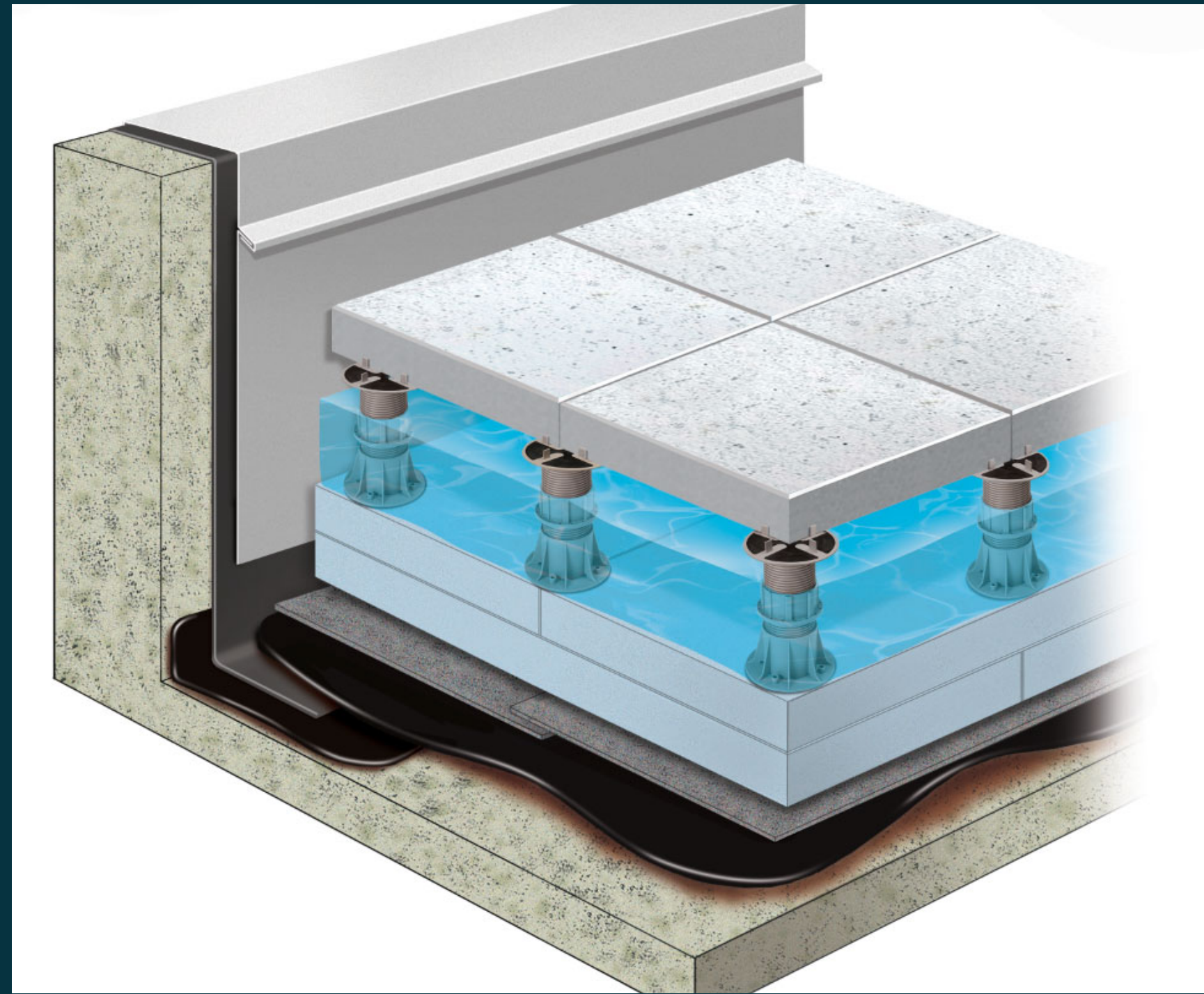
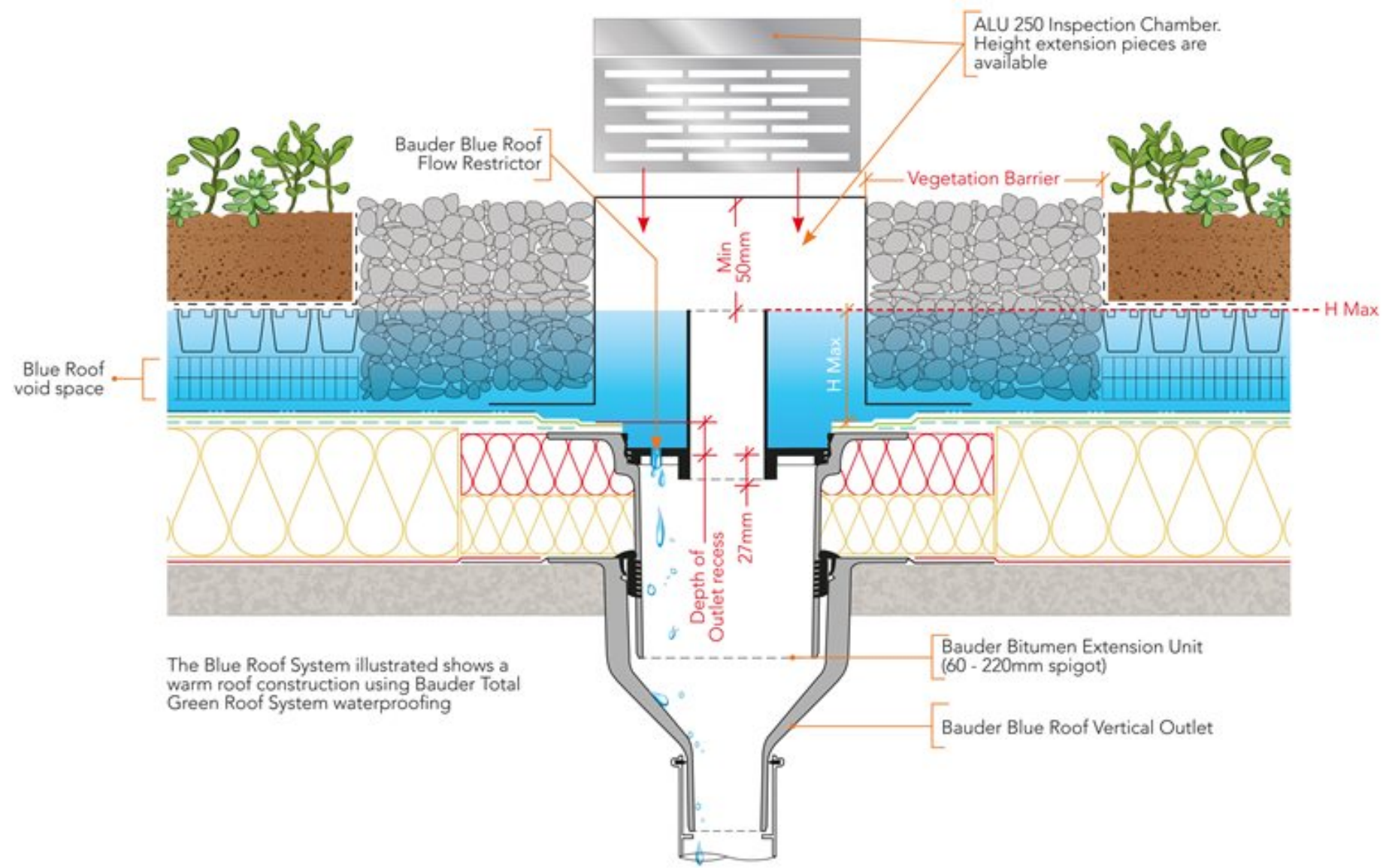

# BLUE ROOFING SYSTEM



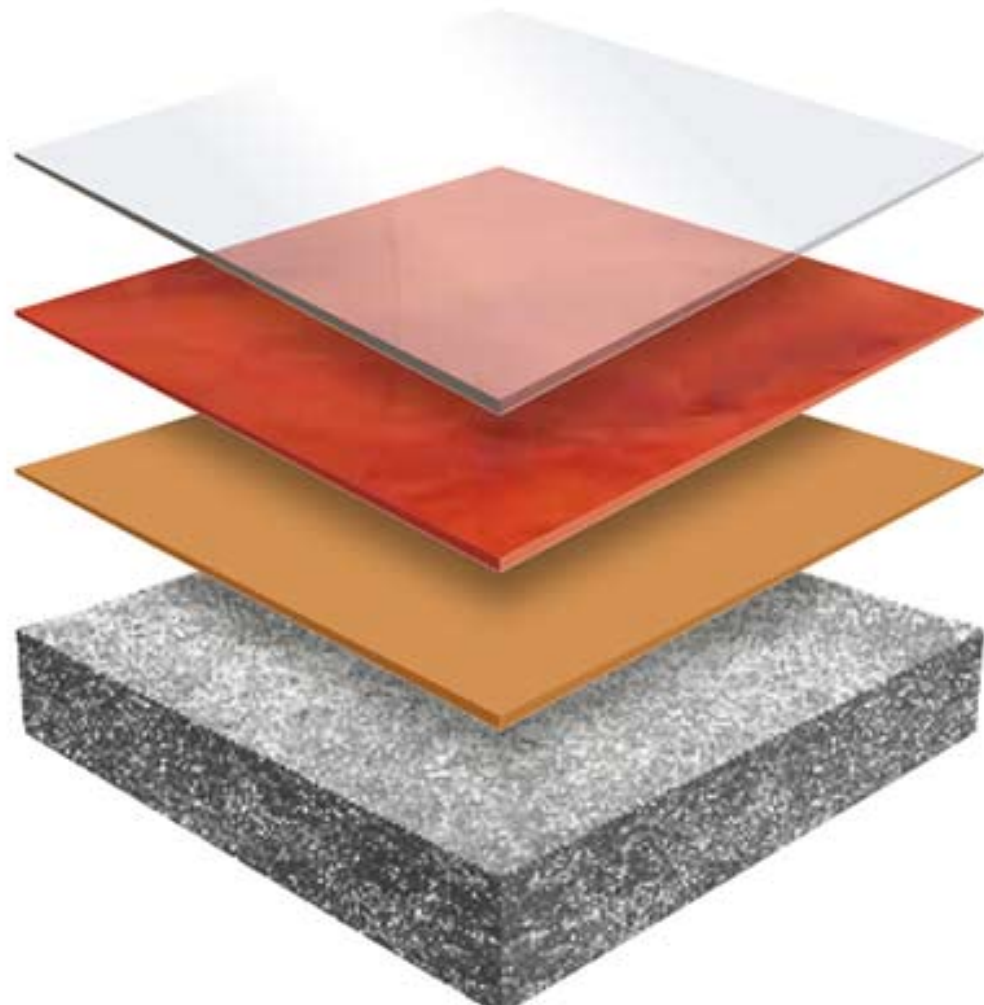

### **Topcoat**

Waterbased or Solvent Based Urethane

### **Basecoat**

Low Viscosity Metallic Epoxy

### **Primer**

Pre-tinted Epoxy



## **FLOORING SYSTEM**

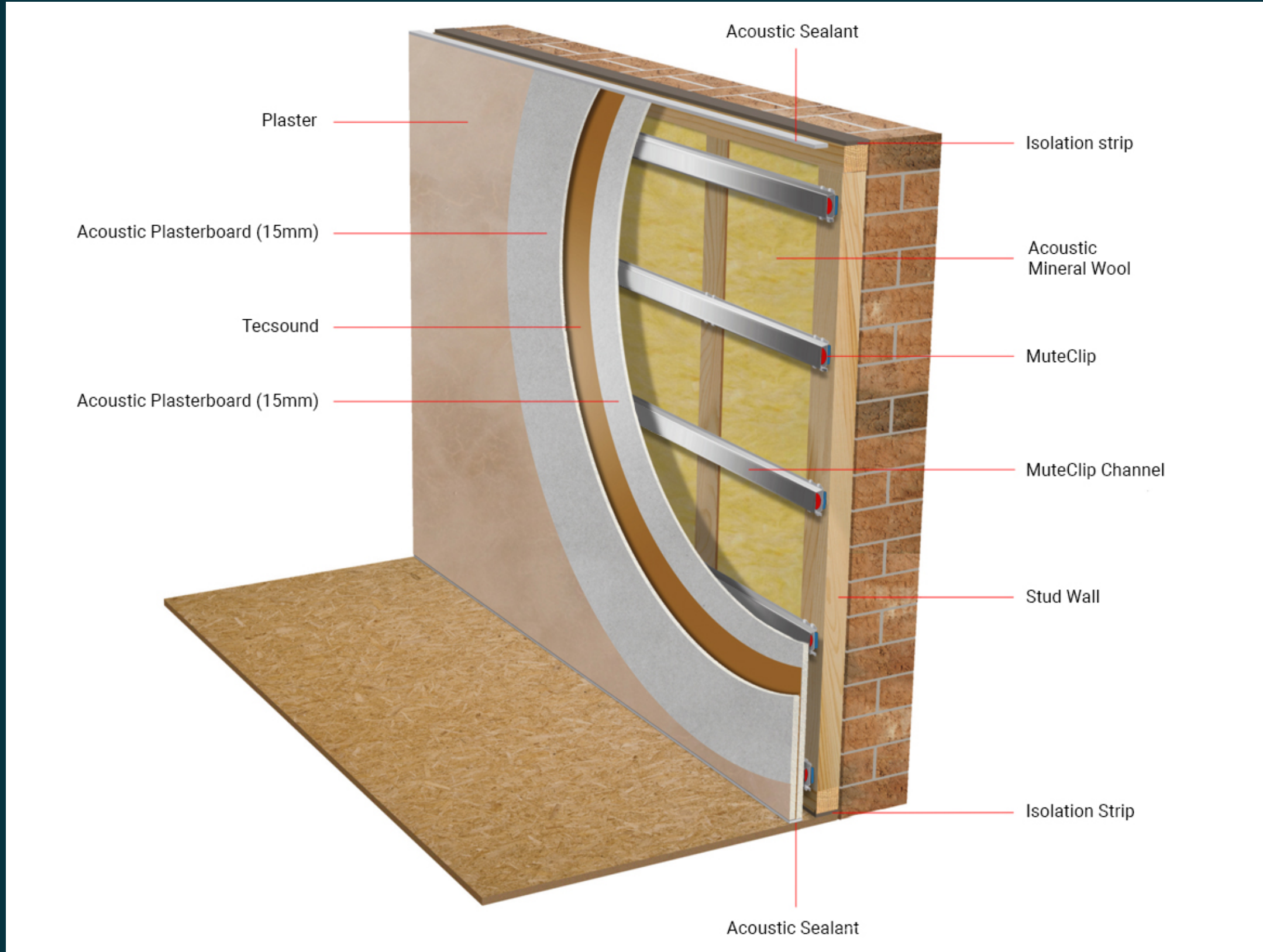

# SOUNDPROOFING SYSTEM



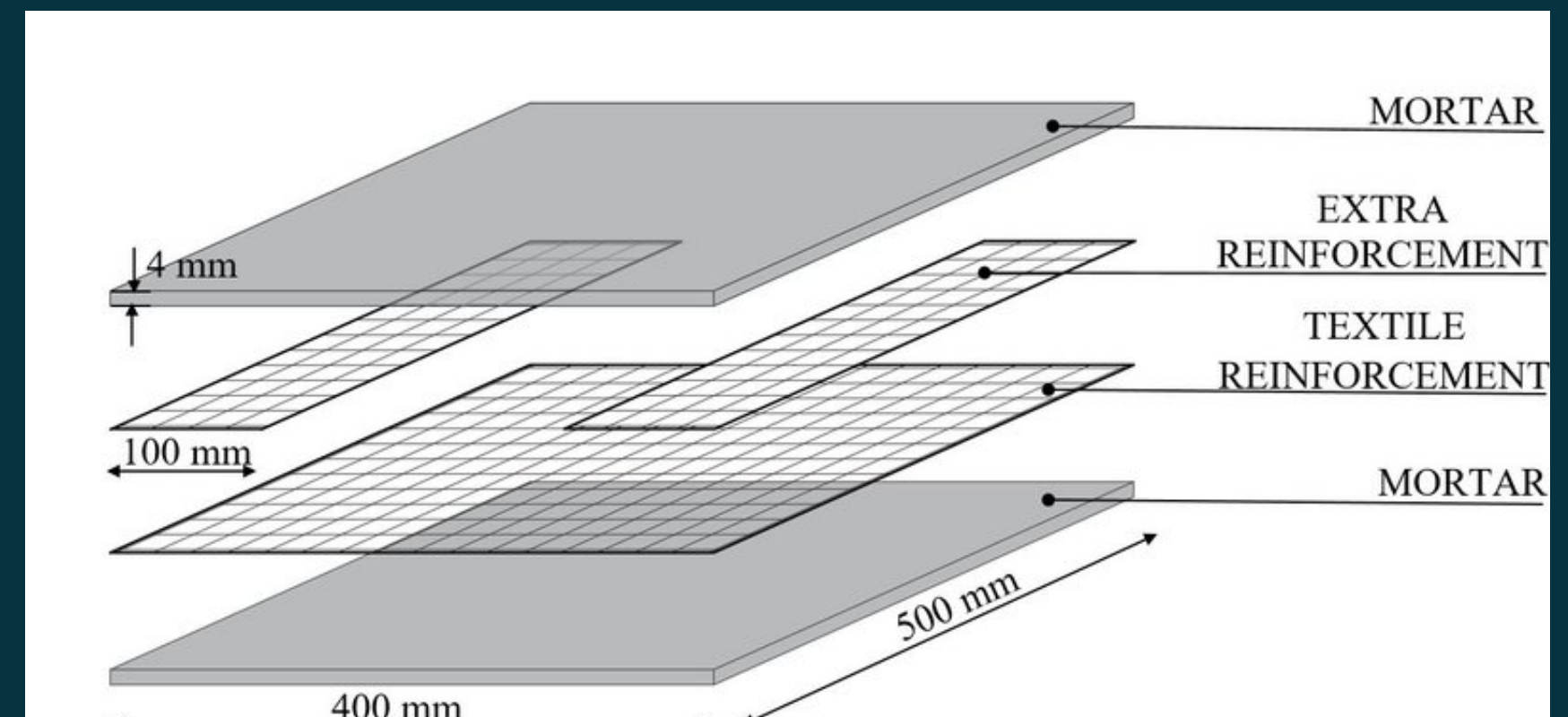
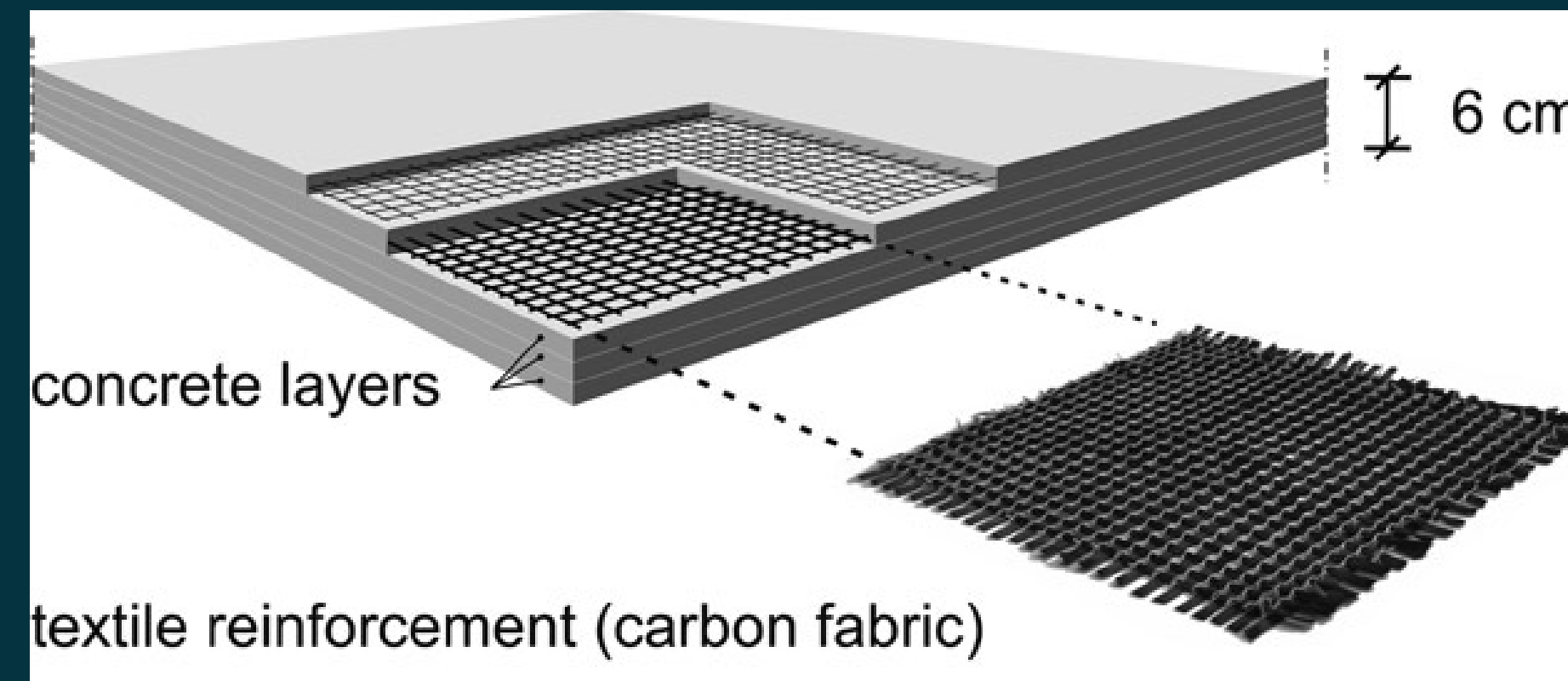

## CONCRETE REPAIR



## CONCRETE REPAIR



# THANK YOU

We look forward to working with you



## Contact Us



+44-743-821-6989



Director@mitest.com.sa  
Ukbranch@mitest.com.sa



[www.themiracleuk.com](http://www.themiracleuk.com)



12 Bishopsworth Rd,  
BS13 7JJ, Bristol - UK

